



THE IMAGINE

N·C MADE



FURNITURE · HAND-BUILT

| CONFIGURATIONS | | WIDTH | DEPTH | HEIGHT |
|----------------|-------------------------|--------|--------|--------|
| 84505 | IMAGINE OTTOMAN | 39 IN. | 39 IN. | 14 IN. |
| 84509 | IMAGINE CORNER CHAIR | 39 IN. | 39 IN. | 34 IN. |
| 84510 | IMAGINE TWO ARM CHAIR | 45 IN. | 39 IN. | 34 IN. |
| 84511 | IMAGINE RIGHT ARM CHAIR | 42 IN. | 39 IN. | 34 IN. |
| 84512 | IMAGINE LEFT ARM CHAIR | 42 IN. | 39 IN. | 34 IN. |
| 84513 | IMAGINE ARMLESS CHAIR | 39 IN. | 39 IN. | 34 IN. |

THE IMAGINE

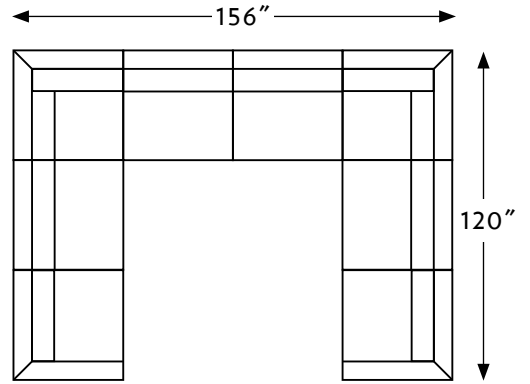

- SHOWN
- 84509 CORNER CHAIR
 - 84511 RIGHT ARM CHAIR
 - 84512 LEFT ARM CHAIR
 - 84513 ARMLESS CHAIR

845 IMAGINE | 1:50 SCALE SHOWN

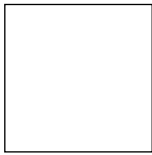

| | |
|-------|----------------|
| 84505 | OTTOMAN |
| TOTAL | W39" D39" H14" |
| SEAT | W39" D39" H21" |
| ARMS | --- --- --- |

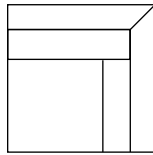

| | |
|-------|----------------|
| 84509 | CORNER CHAIR |
| TOTAL | W39" D39" H34" |
| SEAT | W28" D25" H21" |
| ARMS | --- --- H27" |

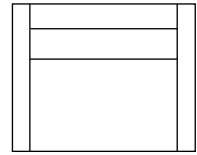

| | |
|-------|----------------|
| 84510 | TWO ARM CHAIR |
| TOTAL | W45" D39" H34" |
| SEAT | W28" D25" H21" |
| ARMS | --- --- H25" |

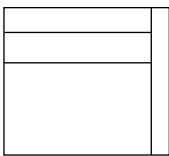

| | |
|-------|-----------------|
| 84511 | RIGHT ARM CHAIR |
| TOTAL | W42" D39" H34" |
| SEAT | W28" D25" H21" |
| ARMS | --- --- H25" |

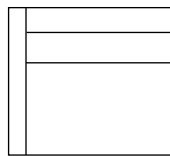

| | |
|-------|----------------|
| 84512 | LEFT ARM CHAIR |
| TOTAL | W42" D39" H34" |
| SEAT | W28" D25" H21" |
| ARMS | --- --- H25" |

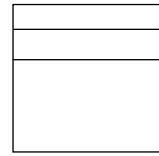

| | |
|-------|----------------|
| 84513 | ARMLESS CHAIR |
| TOTAL | W39" D39" H34" |
| SEAT | W39" D25" H21" |
| ARMS | --- --- --- |